

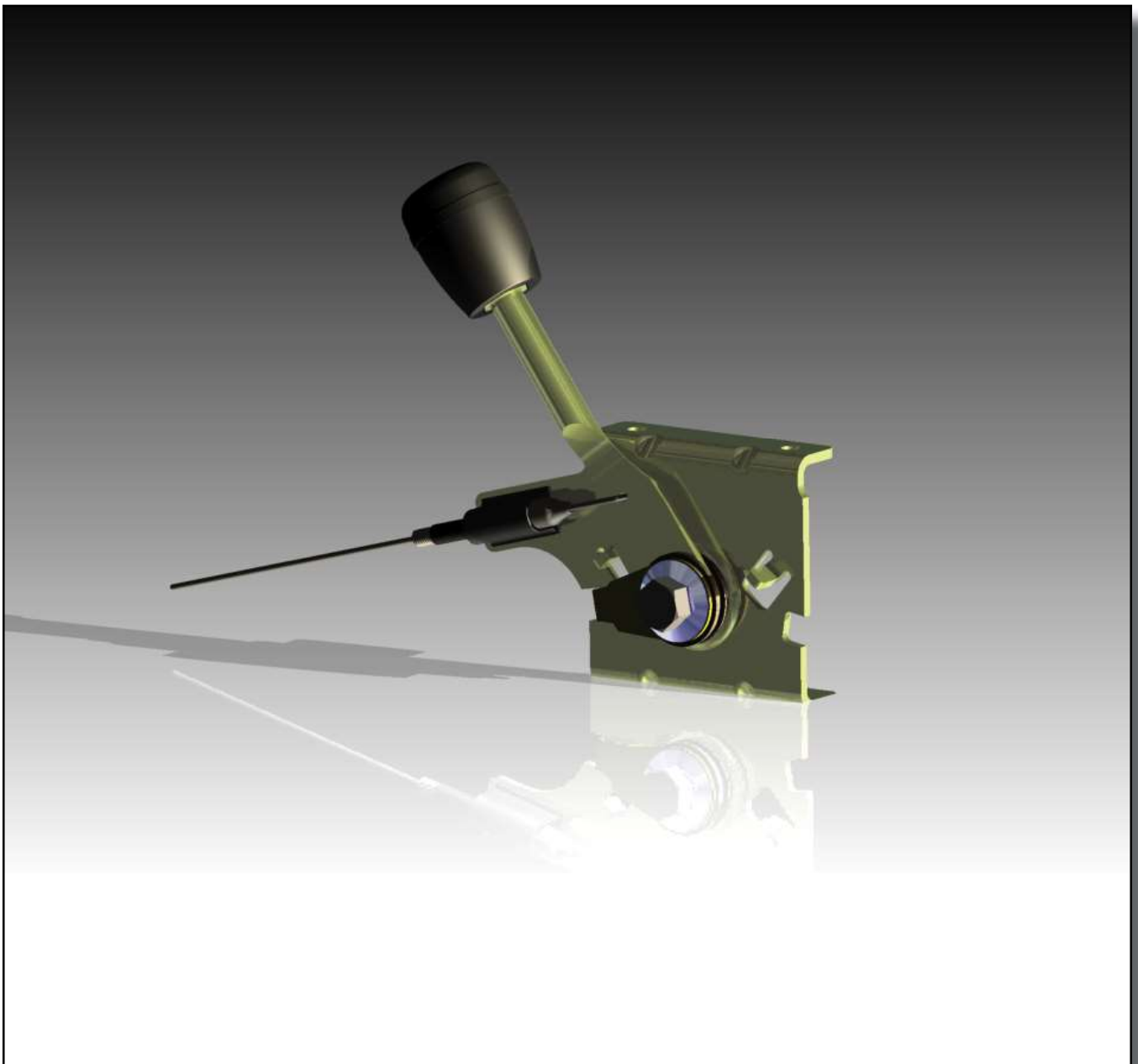

Controls for a world in motion

COMMERCIAL CONTROLS



WESCON CONTROLS

Commercial Control Positive Action Friction

12-4001/12-4002 Panel Mount Control

L.H.Version Shown: 12-4001 Series

R.H.Version (Hidden): 12-4002 Series

Materials: Lever 3/8 dia.

Bracket 12 Ga. (.10)

Finish: Plated for Corrosion Protection

Force @ Base of Knob: 10 lbs. (Force options available)

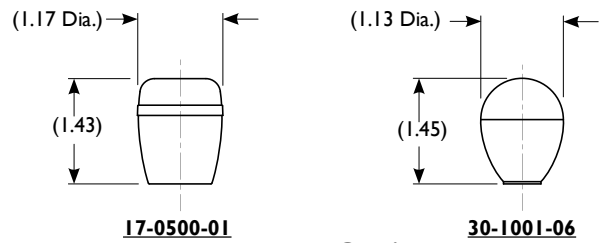

Knob Options

Control Length "L" (Inches)	"X"
00.00 to 23.99	± .12
24.00 to 59.99	± .18
60.00 to 119.99	± .25
120.00 to 240.00	± .50

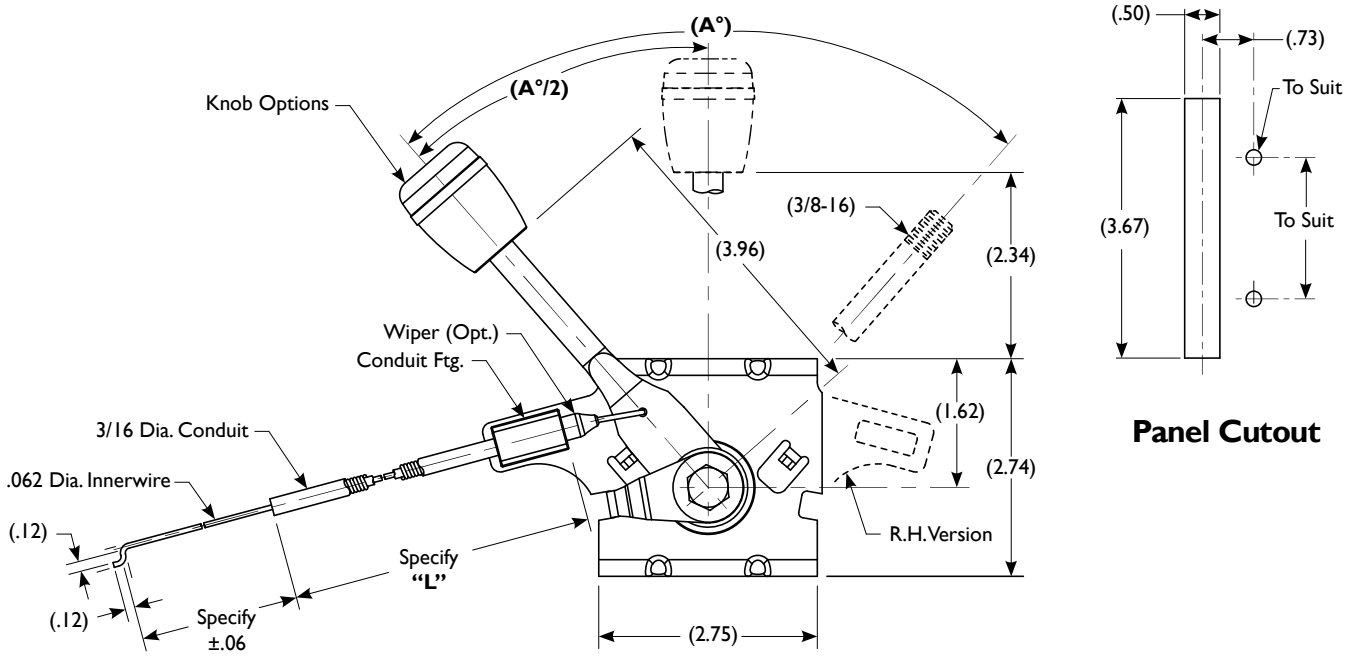
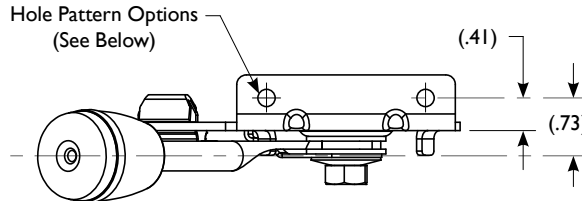

Panel Cutout

Innerwire Travel	Angle A°	Head Assy	Lever	L.H. Bkt.	R.H. Bkt.
1.75	82°	24-4001-01 (L.H.) / 24-4002-01 (R.H.)	27-4000-02 (Long)	28-4000-01	28-4000-02
1.62	82°	24-4001-02 (L.H.) / 24-4002-02 (R.H.)	27-4000-01 (Short)	28-4000-01	28-4000-02
1.32	61°	24-4001-03 (L.H.) / 24-4002-03 (R.H.)	27-4000-02 (Long)	28-4000-08	28-4000-09
1.25	61°	24-4001-04 (L.H.) / 24-4002-04 (R.H.)	27-4000-01 (Short)	28-4000-08	28-4000-09
.97	44°	24-4001-05 (L.H.) / 24-4002-05 (R.H.)	27-4000-02 (Long)	28-4000-13	28-4000-14
.91	44°	24-4001-06 (L.H.) / 24-4002-06 (R.H.)	27-4000-01 (Short)	28-4000-13	28-4000-14

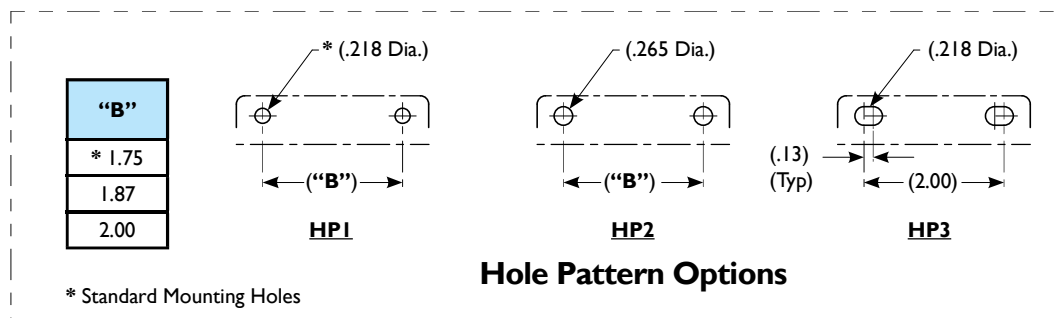

* Standard Mounting Holes

Hole Pattern Options

Commercial Control Negative Action Friction

12-4003/12-4004 Panel Mount Control

L.H.Version Shown: 12-4003 Series

R.H.Version (Hidden): 12-4004 Series

Materials: Lever 3/8 dia.

Bracket 12 Ga. (.10)

Finish: Plated for Corrosion Protection

Force @ Base of Knob: 10 lbs. (Force options available)

Control Length "L" (Inches)	"X"
00.00 to 23.99	± .12
24.00 to 59.99	± .18
60.00 to 119.99	± .25
120.00 to 240.00	± .50

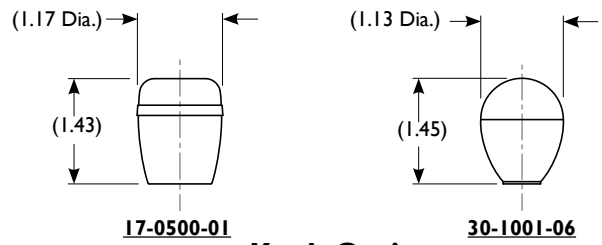

Knob Options

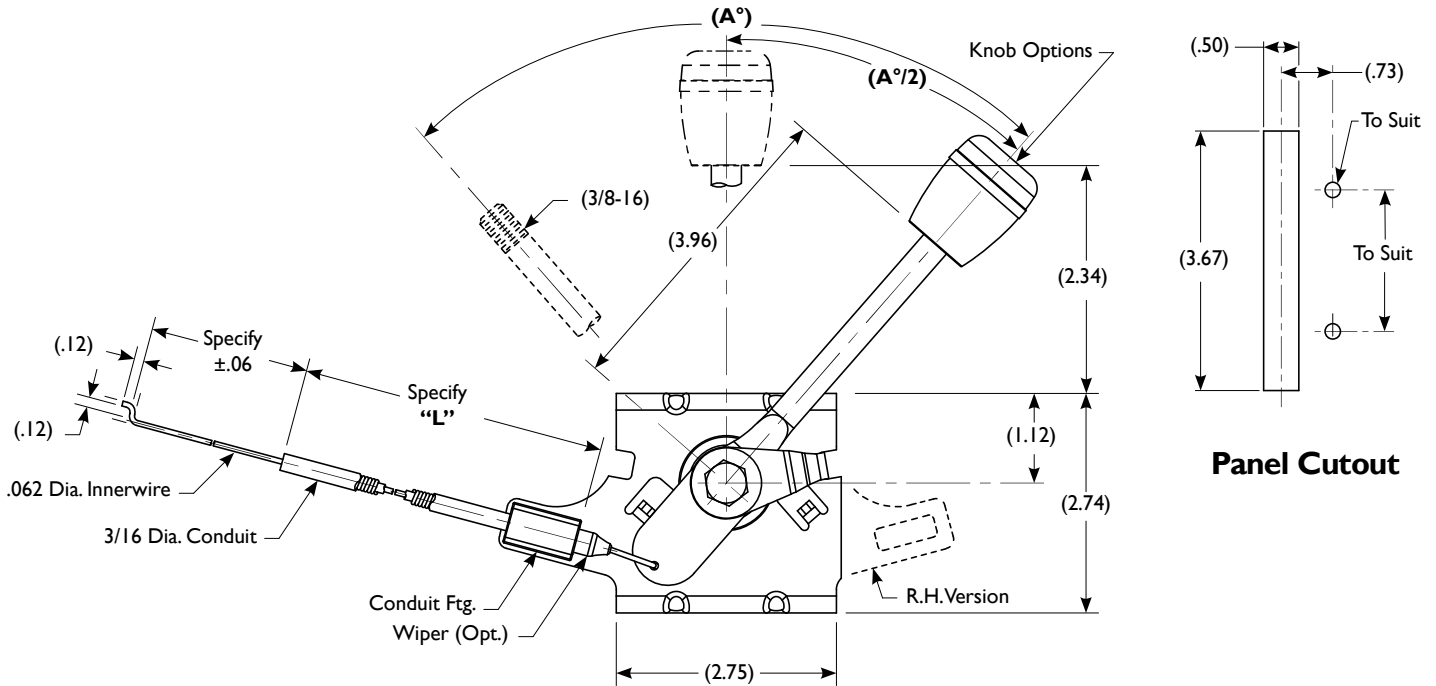
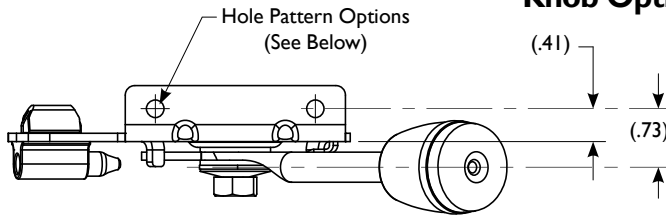

Panel Cutout

Innerwire Travel	Angle A°	Head Assy	Lever	R.H. Bkt.	L.H. Bkt.
1.75	82°	24-4003-01 (L.H.) / 24-4004-01 (R.H.)	27-4000-06 (Long)	28-4000-01	28-4000-02
1.62	82°	24-4003-02 (L.H.) / 24-4004-02 (R.H.)	27-4000-05 (Short)	28-4000-01	28-4000-02
1.32	61°	24-4003-03 (L.H.) / 24-4004-03 (R.H.)	27-4000-06 (Long)	28-4000-08	28-4000-09
1.25	61°	24-4003-04 (L.H.) / 24-4004-04 (R.H.)	27-4000-05 (Short)	28-4000-08	28-4000-09
.97	44°	24-4003-05 (L.H.) / 24-4004-05 (R.H.)	27-4000-06 (Long)	28-4000-13	28-4000-14
.91	44°	24-4003-06 (L.H.) / 24-4004-06 (R.H.)	27-4000-05 (Short)	28-4000-13	28-4000-14

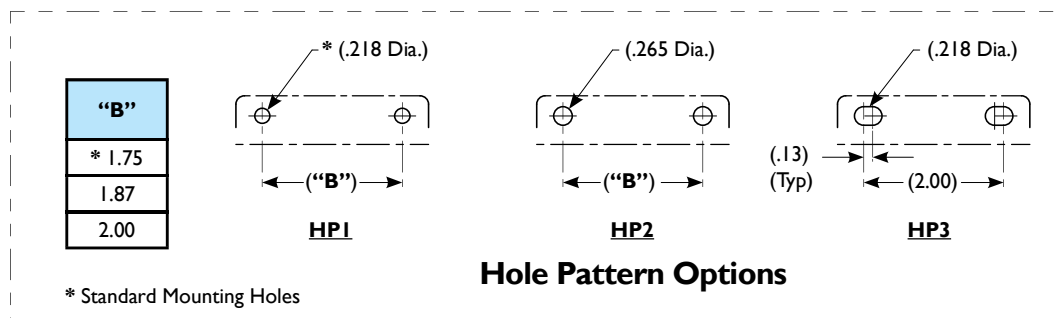

Commercial Control Positive Action Detent

12-4005/12-4006 Panel Mount Control

L.H.Version Shown: 12-4005 Series

R.H.Version (Hidden): 12-4006 Series

Materials: Lever 3/8 dia.

Bracket 12 Ga. (.10)

Finish: Plated for Corrosion Protection

Force @ Base of Knob: 10 lbs. (Force options available)

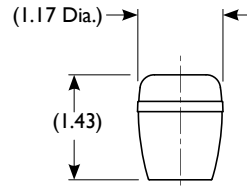

17-0500-01

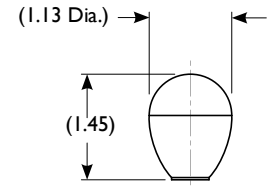

30-1001-06

Knob Options

Control Length "L" (Inches)	"X"
00.00 to 23.99	± .12
24.00 to 59.99	± .18
60.00 to 119.99	± .25
120.00 to 240.00	± .50

Hole Pattern Options
(See Below)

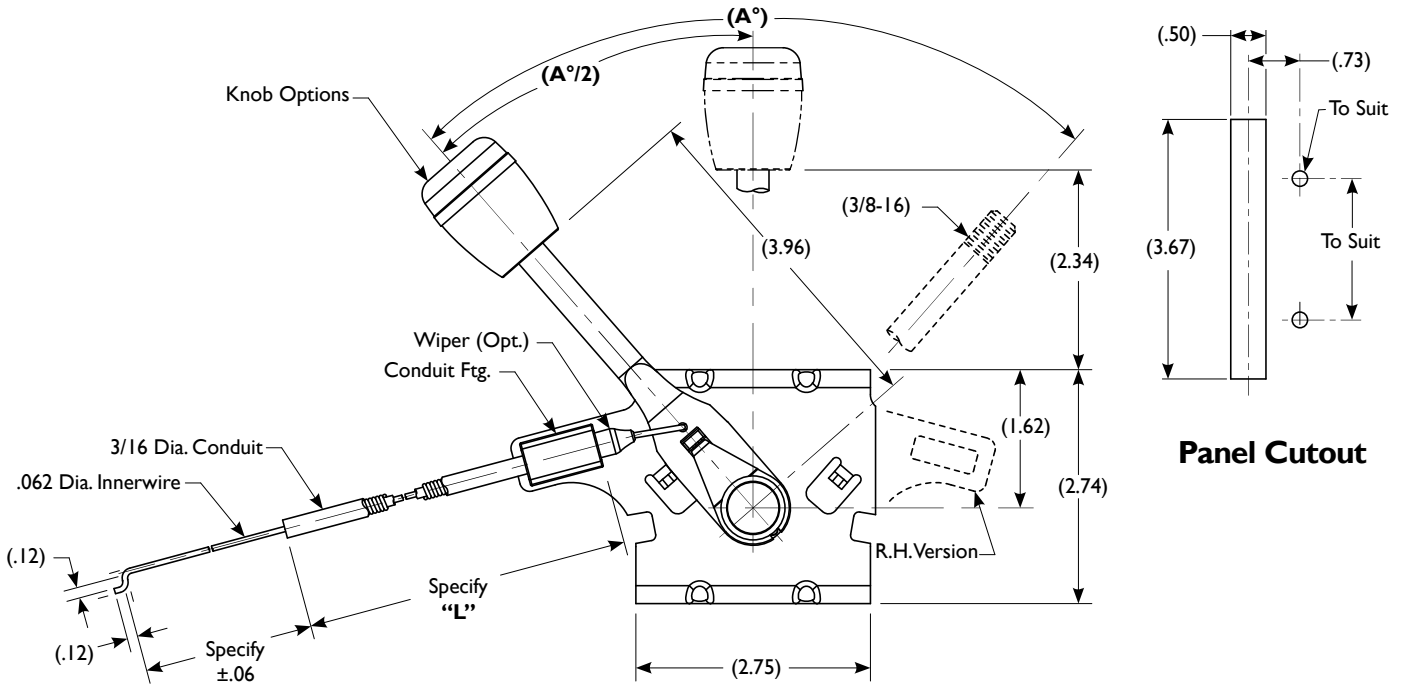
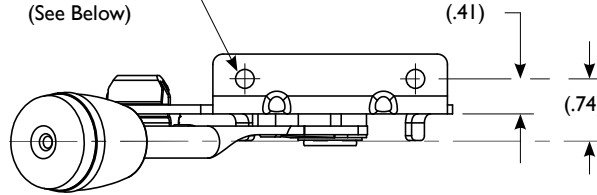

Panel Cutout

Innerwire Travel	Angle A°	Head Assy	Lever	L.H. Bkt.	R.H. Bkt.	Detent at Fully Extended
1.75	82°	24-4005-01 (L.H.) / 24-4006-01 (R.H.)	27-4000-04 (Long)	28-4000-03	28-4000-04	41°
1.62	82°	24-4005-02 (L.H.) / 24-4006-02 (R.H.)	27-4000-03 (Short)	28-4000-03	28-4000-04	41°
1.32	61°	24-4005-03 (L.H.) / 24-4006-03 (R.H.)	27-4000-04 (Long)	28-4000-10	28-4000-11	30.5°
1.25	61°	24-4005-04 (L.H.) / 24-4006-04 (R.H.)	27-4000-03 (Short)	28-4000-10	28-4000-11	30.5°
.97	44°	24-4005-05 (L.H.) / 24-4006-05 (R.H.)	27-4000-04 (Long)	28-4000-15	28-4000-16	22°
.91	44°	24-4005-06 (L.H.) / 24-4006-06 (R.H.)	27-4000-03 (Short)	28-4000-15	28-4000-16	22°

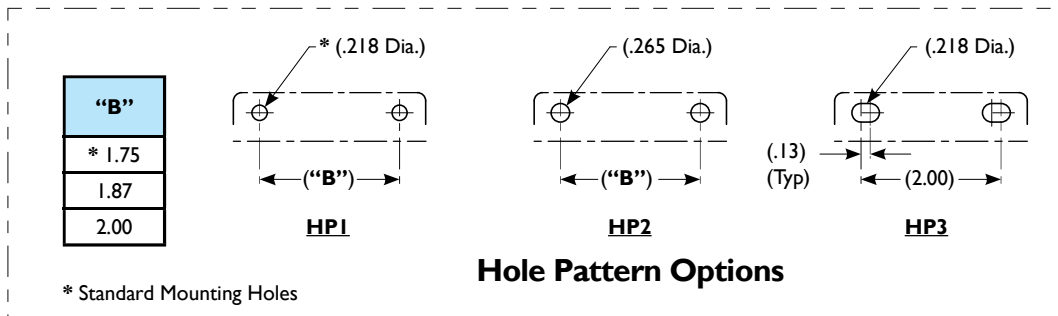

Hole Pattern Options

Commercial Control Negative Action Detent

12-4007/12-4008 Panel Mount Control

L.H.Version Shown: 12-4007 Series

R.H.Version (Hidden): 12-4008 Series

Materials: Lever 3/8 dia.

Bracket 12 Ga. (.10)

Finish: Plated for Corrosion Protection

Force @ Base of Knob: 10 lbs. (Force options available)

Control Length "L" (Inches)	"X"
00.00 to 23.99	± .12
24.00 to 59.99	± .18
60.00 to 119.99	± .25
120.00 to 240.00	± .50

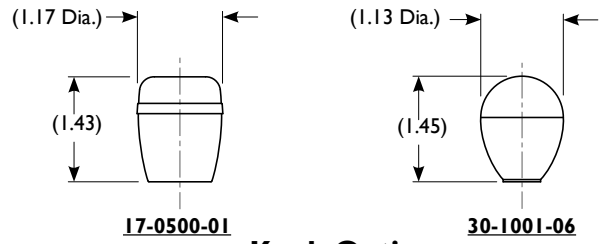

Knob Options

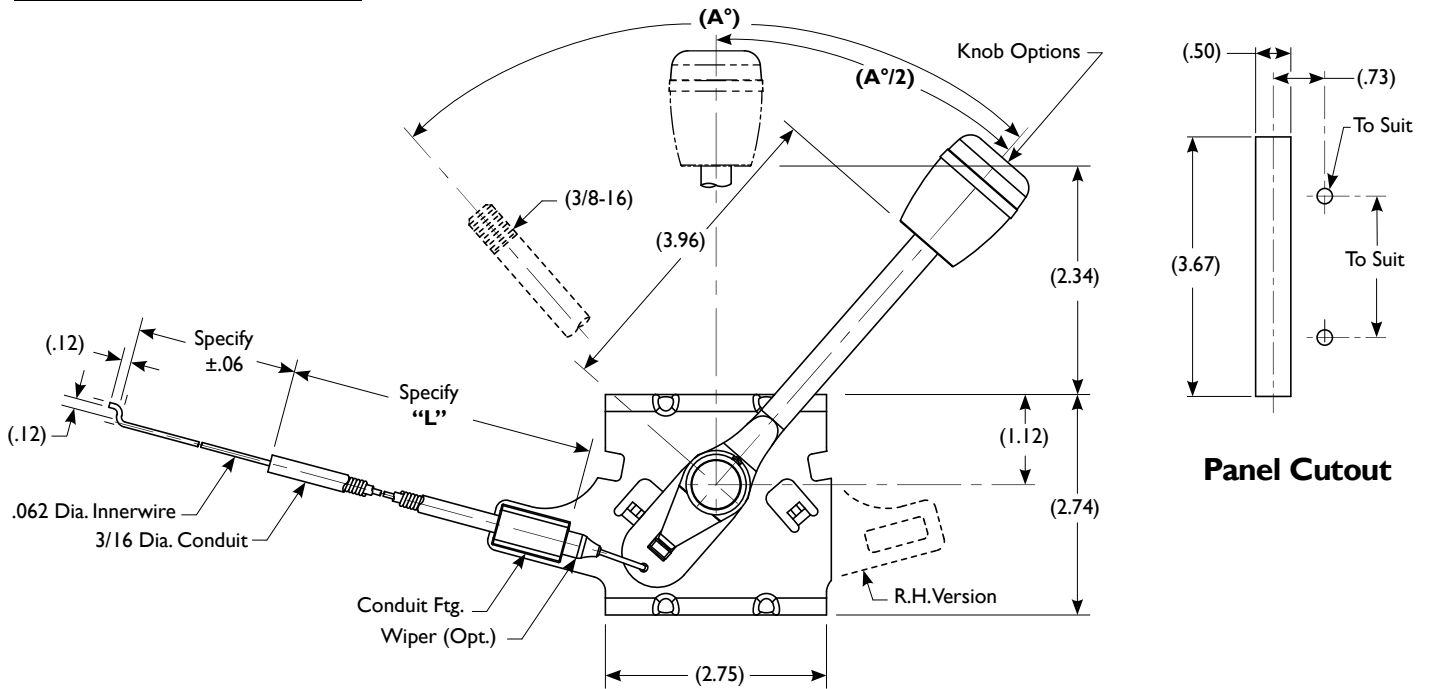
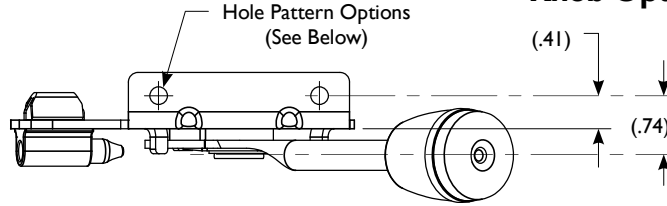

Panel Cutout

Innerwire Travel	Angle A°	Head Assy	Lever	R.H. Bkt.	L.H. Bkt.	Detent at Fully Extended
1.75	82°	24-4007-01 (L.H.) / 24-4008-01 (R.H.)	27-4000-08 (Long)	28-4000-03	28-4000-04	41°
1.62	82°	24-4007-02 (L.H.) / 24-4008-02 (R.H.)	27-4000-07 (Short)	28-4000-03	28-4000-04	41°
1.32	61°	24-4007-03 (L.H.) / 24-4008-03 (R.H.)	27-4000-08 (Long)	28-4000-10	28-4000-11	30.5°
1.25	61°	24-4007-04 (L.H.) / 24-4008-04 (R.H.)	27-4000-07 (Short)	28-4000-10	28-4000-11	30.5°
.97	44°	24-4007-05 (L.H.) / 24-4008-05 (R.H.)	27-4000-08 (Long)	28-4000-15	28-4000-16	22°
.91	44°	24-4007-06 (L.H.) / 24-4008-06 (R.H.)	27-4000-07 (Short)	28-4000-15	28-4000-16	22°

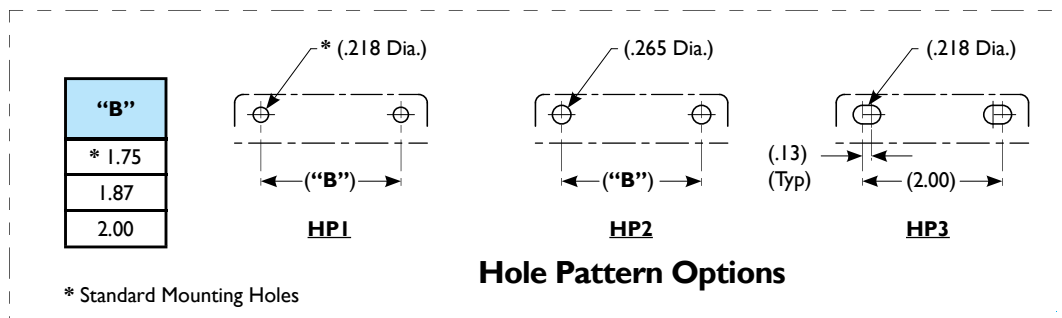

Hole Pattern Options

Commercial Control Detent Options

12-4005/12-4006 Panel Mount Control

L.H.Version: 12-4005 Series
R.H.Version: 12-4006 Series

Positive Action

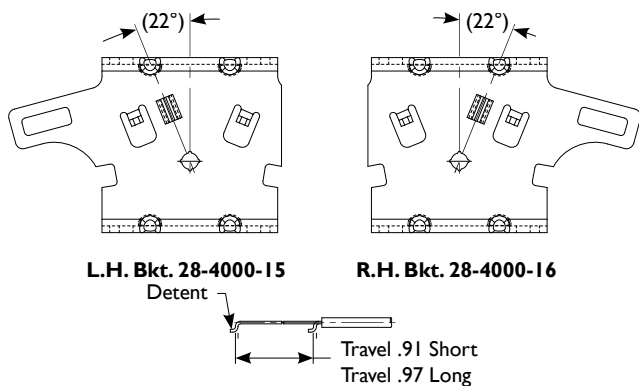
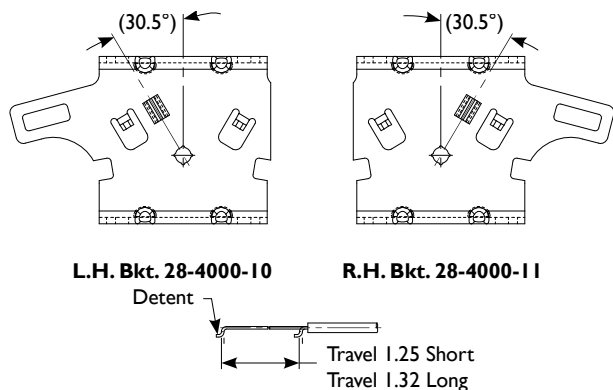
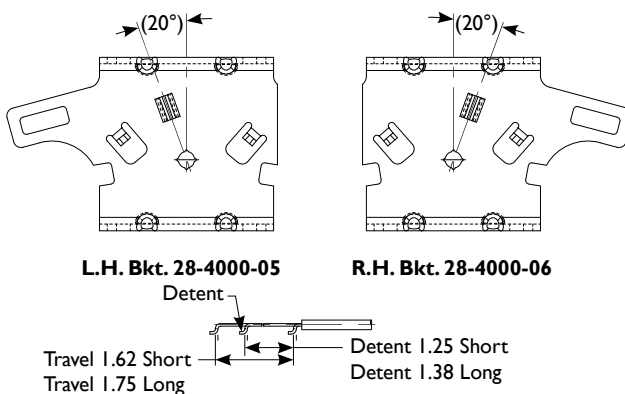
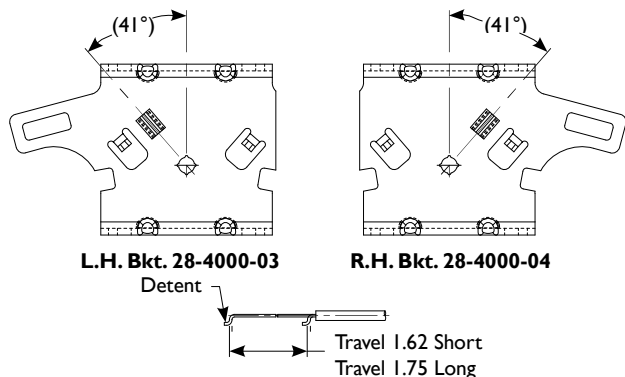

12-4007/12-4008 Panel Mount Control

L.H.Version: 12-4007 Series
R.H.Version: 12-4008 Series

Negative Action

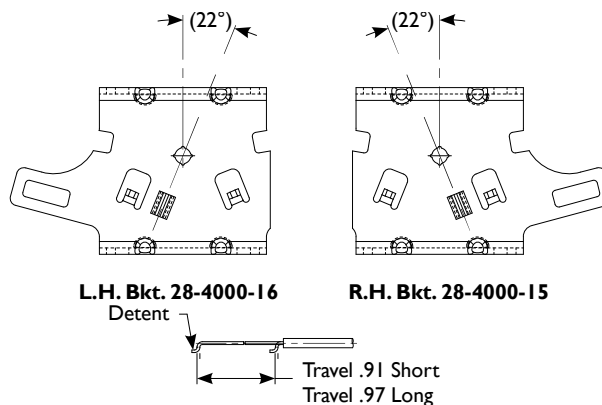
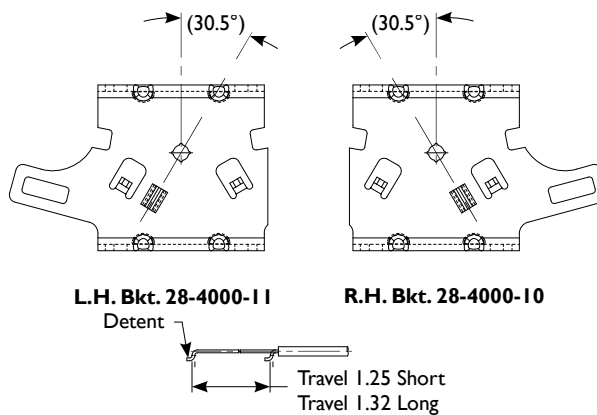
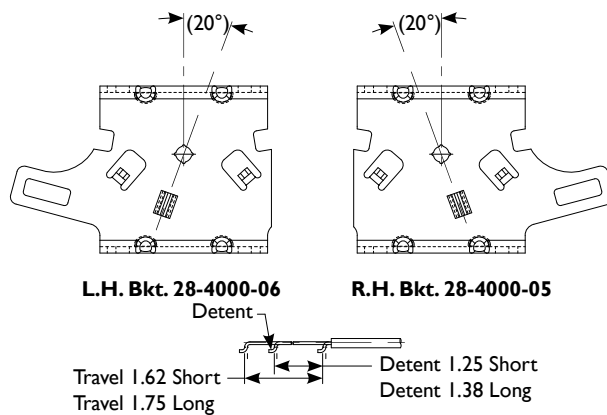
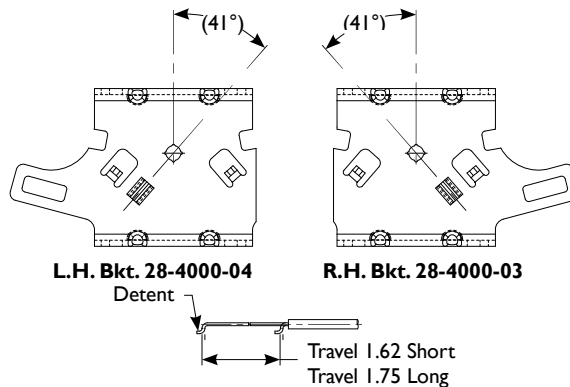

TAKE A LOOK AT OTHER WESCON PRODUCTS



LIGHT DUTY MECHANICAL
CONTROL SYSTEMS



PUSH-PULL CABLES
CONTROL SYSTEMS

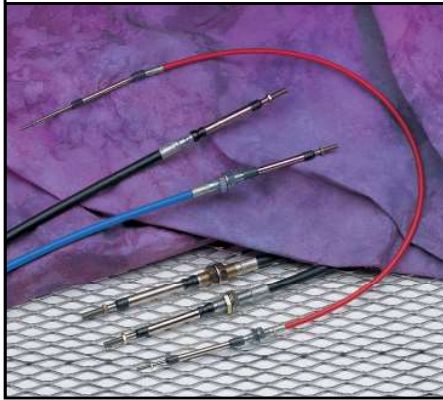

PANEL
CONTROL SYSTEMS



BRAKE CABLE
AND LEVER SYSTEMS



REMOTE VALVE
CONTROL SYSTEMS



ROTARY PUSH-PULL
LEVER CONTROL SYSTEMS



Controls for a world in motion

WESCON CONTROLS, LLC

2533 S. West Wichita, Kansas 67217
316-942-7266 or call toll free 1-800-835-0160

Fax 316-942-5114

www.wesconcontrols.com

ISO 9001 CERTIFIED