

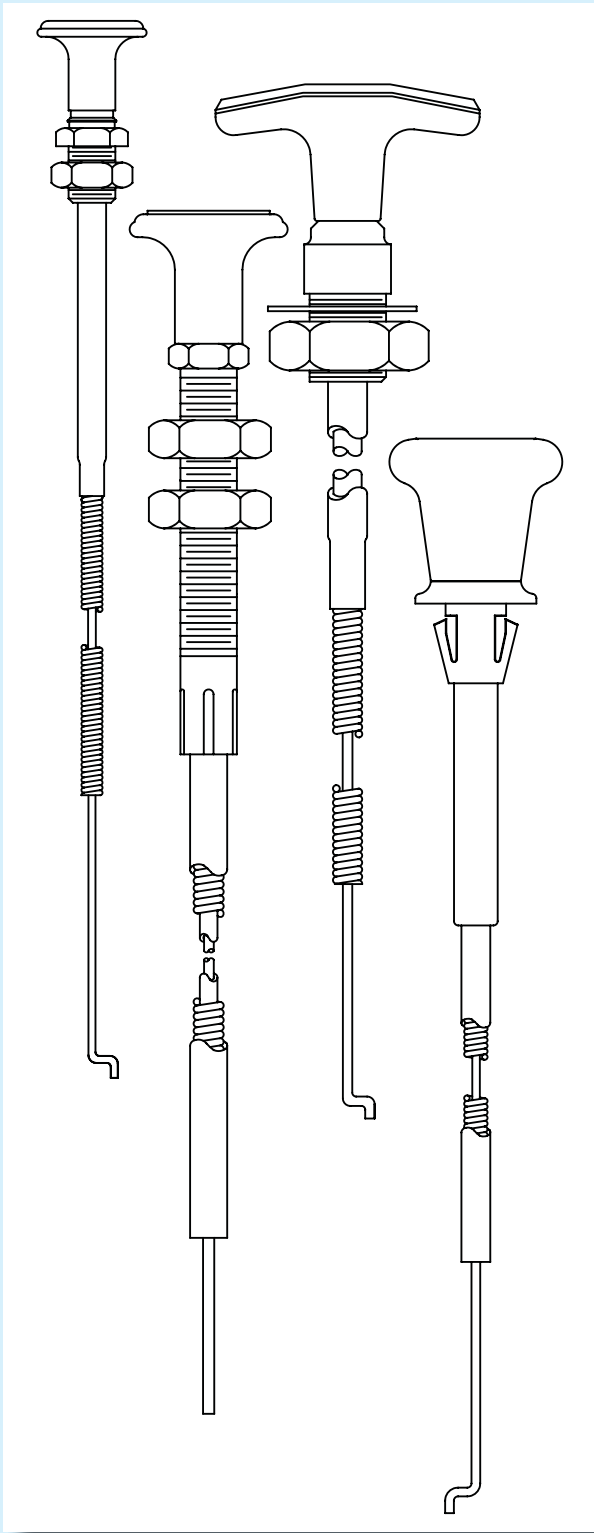

Controls for a world in motion

**Light Duty Push-Pull and  
Turn-to-Lock Controls**



## Creative solutions for every application

- Outdoor Power Equipment
- Construction Equipment
- Utility Vehicles
- ZTR's
- Recreational Equipment
- Tillers
- Snow Products
- Consumer and Commercial Garden Equipment
- Garden Tractors
- ATV's
- Marine
- Medical
- Off-Road Vehicles

**Numerous creative methods of applying Push-Pull Controls, Rotational or Non-Rotational, Turn-to-Lock or Non-Locking in any number of creative applications using a variety of mounting options.**

### **Applications:**

Choke Controls  
Throttle Controls  
HVAC Controls  
Hood Release Controls  
Vent Control

## INDEX

General Design Information ..... 4

Push-Pull Controls ..... 5

Push Button Controls ..... 9

Turn-to-Lock Controls ..... 10

Knobs and Brands ..... 11

Conduit Clips ..... 13

Seals and Wipers ..... 14

Innerwire End Bends ..... 15

## Solid Innerwire Selection Factors/Design Practices

Efficient, economical transmission of linear motion is provided by push-pull conduit and innerwire assemblies. They transmit motion between two fixed points or between points which are changing their relative position. These controls can be routed up, down, over obstacles, even around corners, without intermediate links or pulleys.

Typical applications range from throttle and choke controls for outdoor power equipment to automotive vent and hood controls.

Unlike tension cables, these controls can transmit motion in both the “push” and “pull” directions. However to fully utilize this capability, these controls must be properly integrated into the complete design of the product.

The following describes the various types of Controls, discusses their advantages and limitations and the design practices necessary to obtain efficient motion transfer.

### Input or Output Form

Basically, all push-pull controls, transmit motion by linear displacement of a solid innerwire relative to fixed, flexible conduit (Figure 1).

### Construction

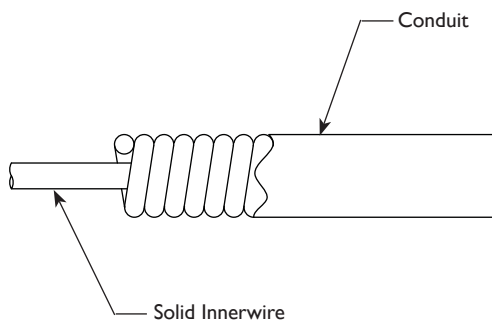

Figure 1

In general, control cost is a function of capacity and performance capabilities. The ideal control is one which meets, but does not necessarily exceed, performance demands.

Minimum bend radii necessary to prevent the innerwire from taking a permanent set are proportional to innerwire diameter. Therefore, the load capacity advantage of the larger innerwire is counter balanced. In many installations, by the difficulties of providing adequate bend radii.

A simple control composed of innerwire and spirally wrapped wire conduit is shown in Figure 2.

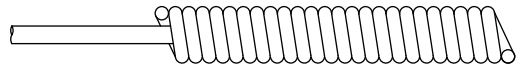

Figure 2

### Load Capacities

Force transmitting capacity is proportional to the diameter of the innerwire, the size of the conduit and the innerwire extension. Maximum recommended push loads are usually about 50 percent of the maximum recommended pull loads.

### Service Life

Even though the innerwire is continuously flexed during operation, the loads in a properly selected innerwire are low enough that the fatigue failure is not normally a problem.

### Bend Radii

Bends in the conduit must be of sufficient radii to permit the innerwire to flow smoothly without acquiring a permanent set. Minimum recommended radii may vary from 5 to 9 inches, depending upon innerwire diameter and construction.

Bends with radii smaller than the recommended minimum values will produce excessive friction and reduce service life. As a rule of thumb, figure minimum bend radius by multiplying innerwire diameter by 100.

Example: For .062 diameter innerwire, multiply .062 by 100 to obtain a 6 inch bend radius.

Normally, load capacity decreases as the travel range increases.

The innerwire provides angular motion by simple deflection of the exposed portion of the innerwire. This deflection should normally be limited to 5 degrees either side of the normal straight position.

## Solid Innerwire Selection Factors/Design Practices

### Lost Motion

The difference between input and output movement, Figure 1, is often the most troublesome factor in control applications. However, if minimum lost motion is an essential performance requirement, it can be provided by proper application techniques.

Lost motion can result both from innerwire deflection and backlash. The clearance necessary between innerwire and conduit permits lost motion.

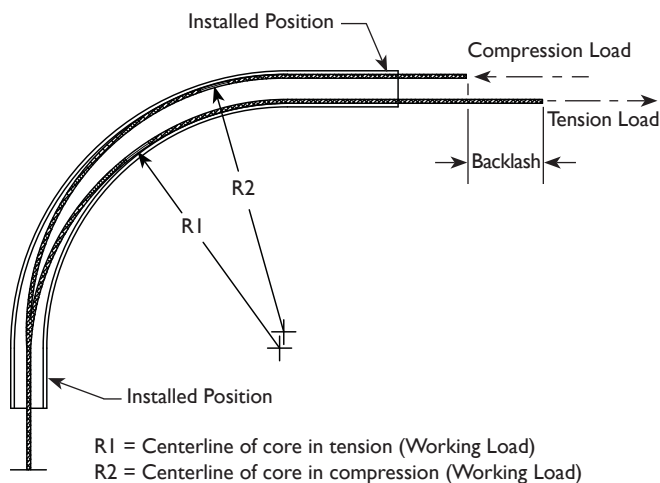

Figure 1

**1. Deflection** - Deflection loss results from “snaking” of the innerwire under compression loads. Snaking depends primarily upon the amount and uniformity of clearance between the innerwire and the conduit. A minimum uniform clearance permits the minimum snaking of column-action buckling of the innerwire when it is under compression loads.

**2. Backlash** (or lost motion) - is caused by clearance between the core diameter and the inside diameter of the conduit. It is present in both the push and pull modes of operation. Backlash is directly proportional to the total degrees of bend in the installed routing and the clearance between the O.D. of the core and the I.D. of the conduit.

### Friction

Even if an innerwire appears to be perfectly straight, there will be a nominal friction loss. Control specifications usually include the necessary data to determine friction loss as a function of the total curvature of the conduit.

### Design Procedure

1. Determine
  - a. Maximum load in each direction required at output end.
  - b. Permissible lost motion.
  - c. Travel required.
  - d. Range of operating temperatures.
  - e. Other unfavorable conditions such as dust, dirt, moisture, chemical corrosion, etc.
2. Use as few bends as possible and keep bend-radii as large as possible.
3. Provide positive location points for each end of the conduit. Total length of the conduit assembly can now be estimated.
4. Determine the proposed installation, duplicating and relative location of the input and output ends, the load required at the output end, as well as the proposed routing and clamping arrangement.
5. Exact innerwire length can be determined now. It should be just enough to provide adequate length when all the manufacturing tolerances of the machine components are combined to produce the maximum overall length. Excess innerwire length necessitates extra bends, which add to the lost motion and friction load.

### Operating Environment

To obtain satisfactory service life, the operating environment must be considered. For example, dust, moisture, heat, chemical corrosion and mechanical damage can lead to premature control failure.

Dust and moisture damage can be controlled by using a lined and or covered conduit. For excessively dusty conditions, a wiper seal may be required.

Chemical corrosion and heat damage are usually controlled by the choice of materials.

Plastic covered conduit is often used to provide the maximum corrosion protection.

Mechanical damage may occur during regular use of the equipment or during overhaul or repair. The conduit should be routed so that it is protected by the basic machine structure, or if this is not practical, additional mechanical protection should be provided in areas of likely damage.

# Push-Pull Controls

## 11-0122 Rotational

**Travels:** 1.00 (Config. 4541)  
2.00 (Config. 4067)  
4.00 (Config. 4204)

**NOTE:** Installation Hole Size = .406 Dia.

 EXTENSION TOLERANCE  
A. With End Bend ±.06  
B. No End Bend ±.18

\* Material Options Available (Galv. or S.S.)

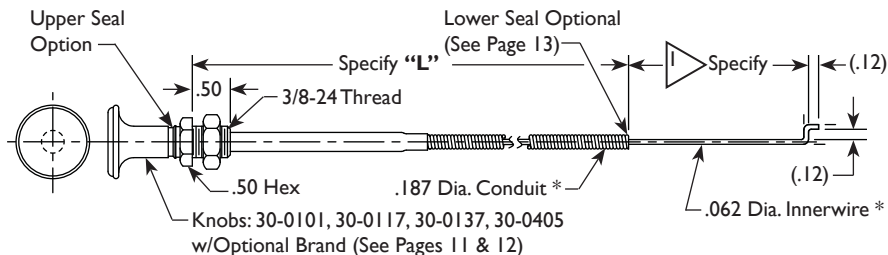

Control Length "L"	Tolerance
00.00" - 23.99"	±.12
24.00" - 59.00"	±.18
60.00" - 119.99"	±.25
120.00" - 240.00"	±.50

## 11-0179 Rotational/ 11-0200 Non-Rotational

**Travel:** 2.00 (Config. 4085)

 EXTENSION TOLERANCE  
A. With End Bend ±.06  
B. No End Bend ±.18

\* Material Options Available (Galv. or S.S.)

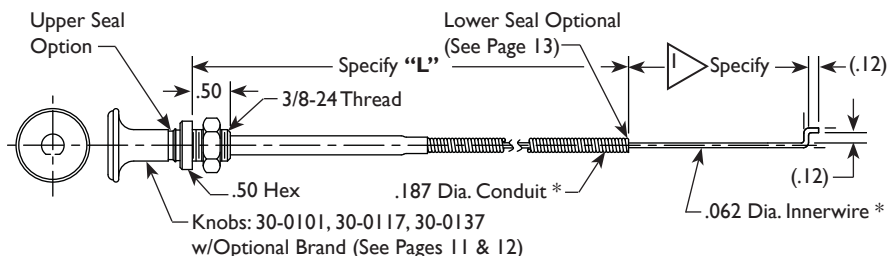

Control Length "L"	Tolerance
00.00" - 23.99"	±.12
24.00" - 59.00"	±.18
60.00" - 119.99"	±.25
120.00" - 240.00"	±.50

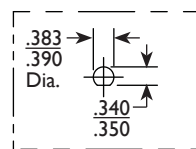

Panel Mount Detail

## 11-0182 Rotational

**Travel:** 2.00 (Config. 0147)  
1.75 (Config. 5142)

 EXTENSION TOLERANCE  
A. With End Bend ±.06  
B. No End Bend ±.18

\* Material Options Available (Galv. or S.S.)

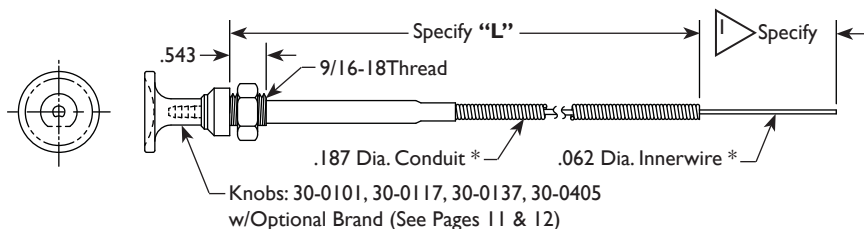

Control Length "L"	Tolerance
00.00" - 23.99"	±.12
24.00" - 59.00"	±.18
60.00" - 119.99"	±.25
120.00" - 240.00"	±.50

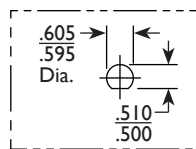

Panel Mount Detail

## 11-0175 Non-Rotational

**Travel:** 2.00 (Config. 5115)  
1.75 (Config. 1261)

 EXTENSION TOLERANCE  
A. With End Bend ±.06  
B. No End Bend ±.18

\* Material Options Available (Galv. or S.S.)

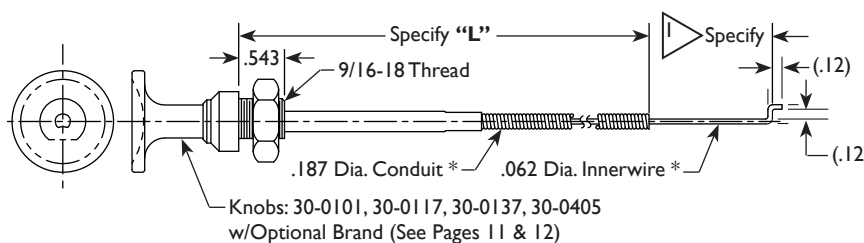

Control Length "L"	Tolerance
00.00" - 23.99"	±.12
24.00" - 59.00"	±.18
60.00" - 119.99"	±.25
120.00" - 240.00"	±.50

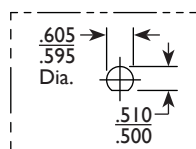

Panel Mount Detail

# Push-Pull Controls

## 11-0196 Rotational

**NOTE:** Installation Hole Size = .328 Dia.

**EXTENSION TOLERANCE**  
 A. With End Bend  $\pm .06$   
 B. No End Bend  $\pm .18$

\* Material Options Available (Galv. or S.S.)

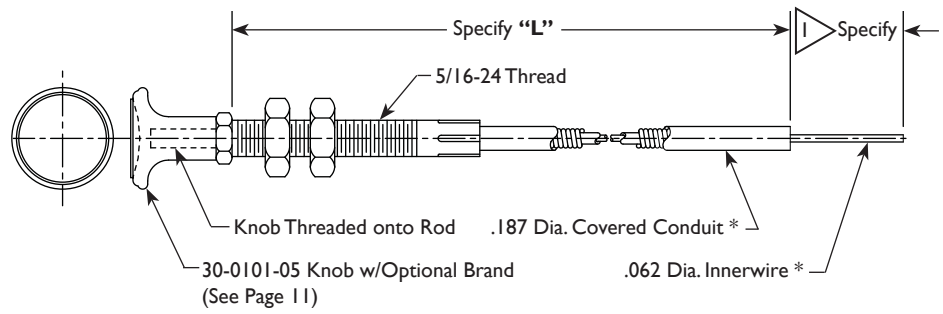

Control Length "L"	Tolerance
00.00" - 23.99"	$\pm .12$
24.00" - 59.00"	$\pm .18$
60.00" - 119.99"	$\pm .25$
120.00" - 240.00"	$\pm .50$

## 11-0123 Rotating, Rear Mount Threaded, 16mm

**Travel Capacity:** 1.50

**EXTENSION TOLERANCE**  
 A. With End Bend  $\pm .06$   
 B. No End Bend  $\pm .18$

\* Material Options Available (Galv. or S.S.)

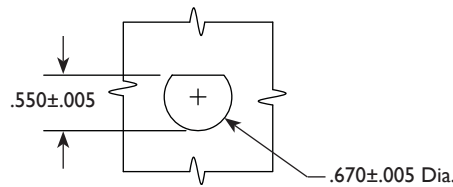
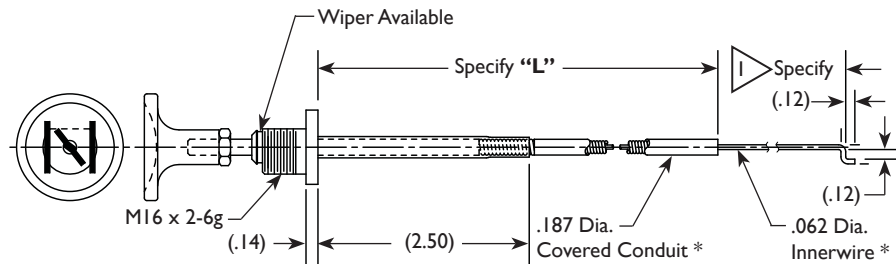

Panel Mount Detail

Control Length "L"	Tolerance
00.00" - 23.99"	$\pm .12$
24.00" - 59.00"	$\pm .18$
60.00" - 119.99"	$\pm .25$
120.00" - 240.00"	$\pm .50$

## 11-0163 Non-Rotational

**EXTENSION TOLERANCE**  
 A. With End Bend  $\pm .06$   
 B. No End Bend  $\pm .18$

\* Material Options Available (Galv. or S.S.)

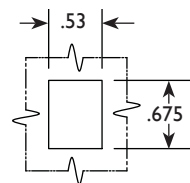
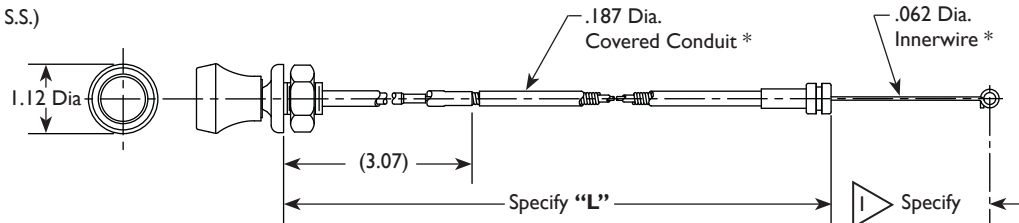

Panel Mount Detail

Control Length "L"	Tolerance
00.00" - 23.99"	$\pm .12$
24.00" - 59.00"	$\pm .18$
60.00" - 119.99"	$\pm .25$
120.00" - 240.00"	$\pm .50$

# Push-Pull Controls

## II-2001 Rotating, Snap-In, Non-Friction

Travel Capacity: 2.00

- EXTENSION TOLERANCE  
 A. With End Bend ±.06  
 B. No End Bend ±.18

\* Material Options Available (Galv. or S.S.)

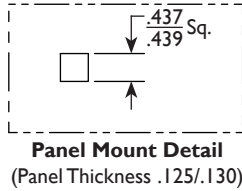
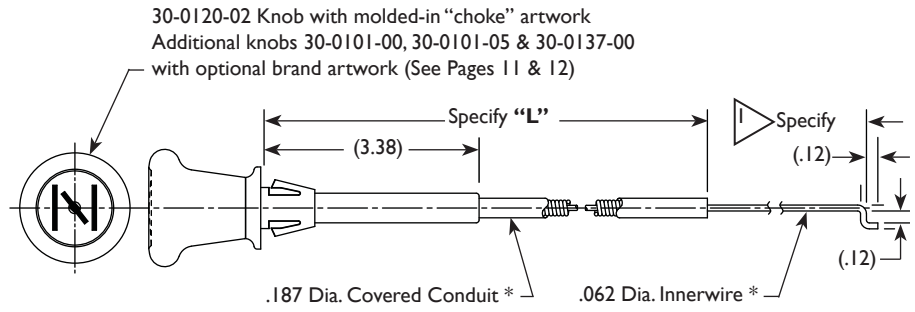

Control Length "L"	Tolerance
00.00" - 23.99"	±.12
24.00" - 59.00"	±.18
60.00" - 119.99"	±.25
120.00" - 240.00"	±.50

## II-2003 Rotating, Snap-N-Seal

Snap in Panel

Travel Capacity: 2.00

- EXTENSION TOLERANCE  
 A. With End Bend ±.06  
 B. No End Bend ±.18

\* Material Options Available (Galv. or S.S.)

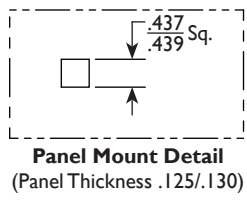
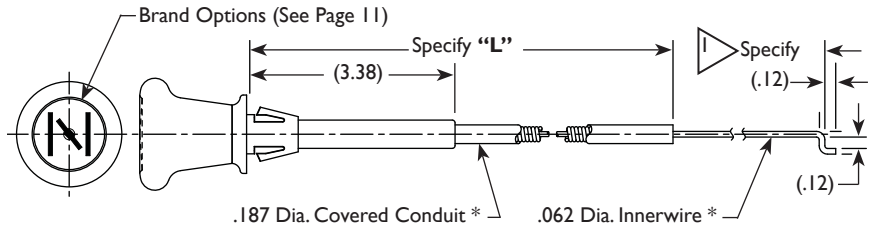

Control Length "L"	Tolerance
00.00" - 23.99"	±.12
24.00" - 59.00"	±.18
60.00" - 119.99"	±.25
120.00" - 240.00"	±.50

## II-2005 Rotating, Snap-N-Seal

NOTE: Installation Hole Size = .41 Dia.

Travel Capacity: 2.00

- EXTENSION TOLERANCE  
 A. With End Bend ±.06  
 B. No End Bend ±.18

\* Material Options Available (Galv. or S.S.)

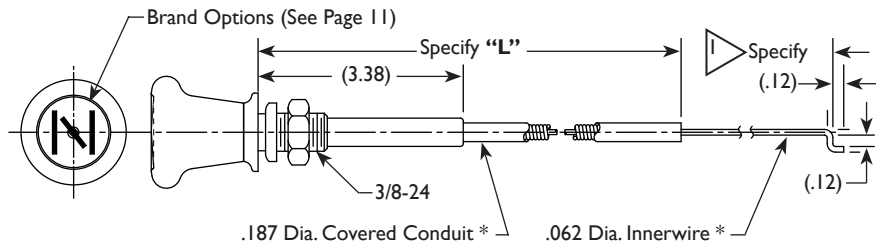

Control Length "L"	Tolerance
00.00" - 23.99"	±.12
24.00" - 59.00"	±.18
60.00" - 119.99"	±.25
120.00" - 240.00"	±.50



# Push Button Controls

## 09-6000/09-6004 Tension Lock Type Controls

### “Push Button” Release

Locks in any position against tension. Max locking force = 50 Lbs.

Travels: 09-6000 1.75 Travel  
09-6004 2.75 Travel

**NOTE:** Installation Hole Size = .41 Dia.

Control Length “L”	Tolerance
00.00” - 23.99”	±.12
24.00” - 59.00”	±.18
60.00” - 119.99”	±.25
120.00” - 240.00”	±.50

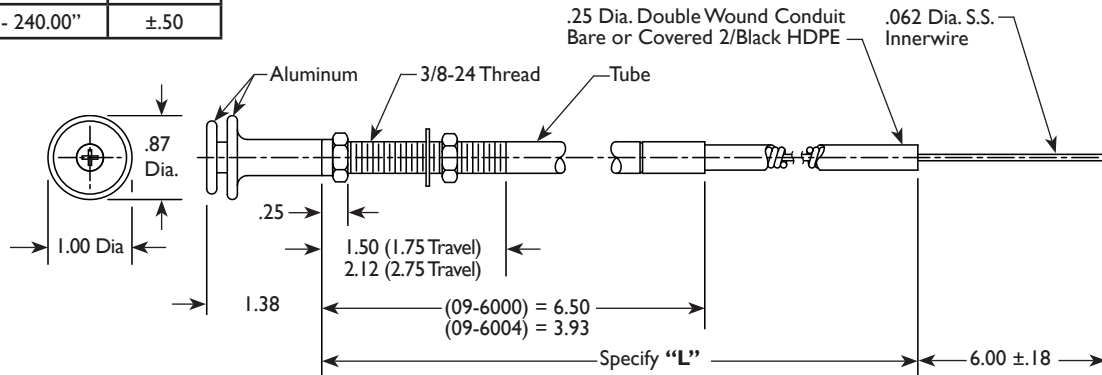

## 09-6001 Dual Control

Travel: 2.75

**NOTE:** Installation Hole Size .41 Dia.

\* Material Options Available (Galv. or S.S.)

Control Length “L”	Tolerance
00.00” - 23.99”	±.12
24.00” - 59.00”	±.18
60.00” - 119.99”	±.25
120.00” - 240.00”	±.50

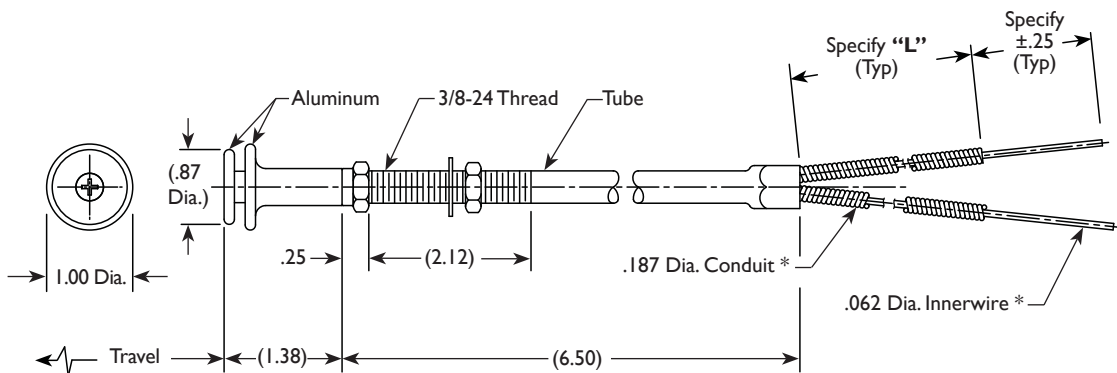

# Turn-to-Lock Controls

## 11-1100 Turn-To-Lock

Travel: 2.00 or 4.00

EXTENSION TOLERANCE  
 A. With End Bend  $\pm .06$   
 B. No End Bend  $\pm .18$

\* Material Options Available (Galv. or S.S.)

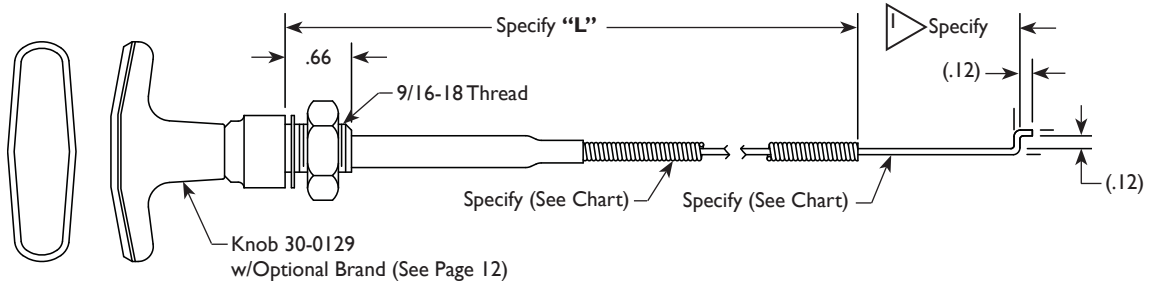

Conduit Size	Wire Size
.187 Dia.	.062 Dia.
7/32 Dia.	.072 Dia.
1/4 Dia.	.080 Dia.

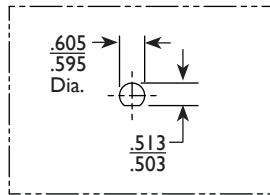

Panel Mount Detail

Control Length "L"	Tolerance
00.00" - 23.99"	$\pm .12$
24.00" - 59.00"	$\pm .18$
60.00" - 119.99"	$\pm .25$
120.00" - 240.00"	$\pm .50$

## 11-0199 Turn-To-Lock

Travels: 1.31  
 1.75  
 4.50

EXTENSION TOLERANCE  
 A. With End Bend  $\pm .06$   
 B. No End Bend  $\pm .18$

\* Material Options Available (Galv. or S.S.)

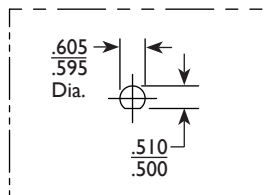
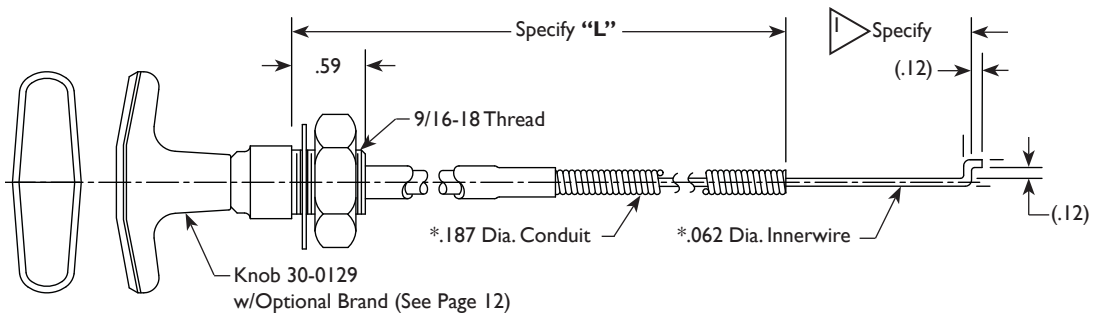

Panel Mount Detail

Control Length "L"	Tolerance
00.00" - 23.99"	$\pm .12$
24.00" - 59.00"	$\pm .18$
60.00" - 119.99"	$\pm .25$
120.00" - 240.00"	$\pm .50$

# Knobs & Brands

## 30-0101-00 Round Knob

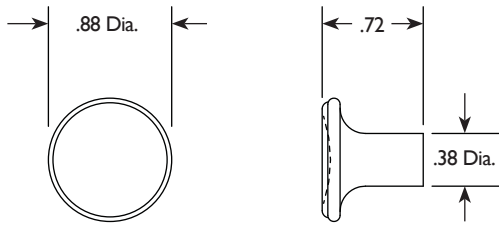

## 25-0542-\* Brands for 30-0101 Knob

\*Insert Dash No.

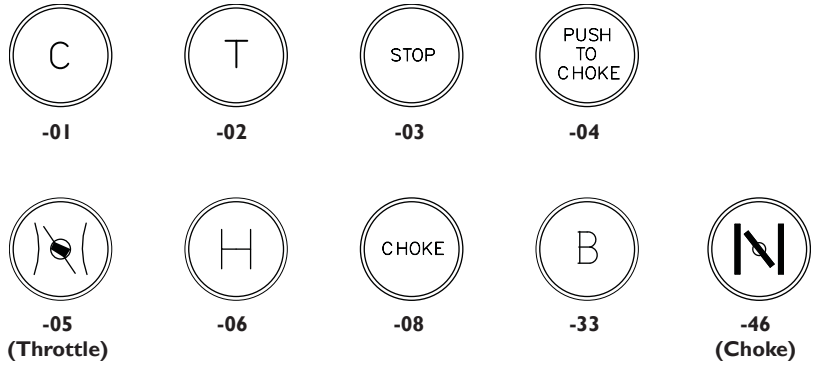

## 30-0137-00 Round Knob

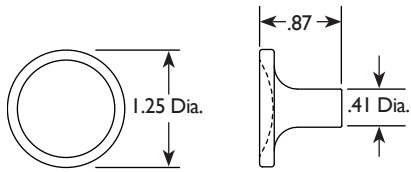

## 25-0542-\* Brands for 30-0137 Knob

\*Insert Dash No.

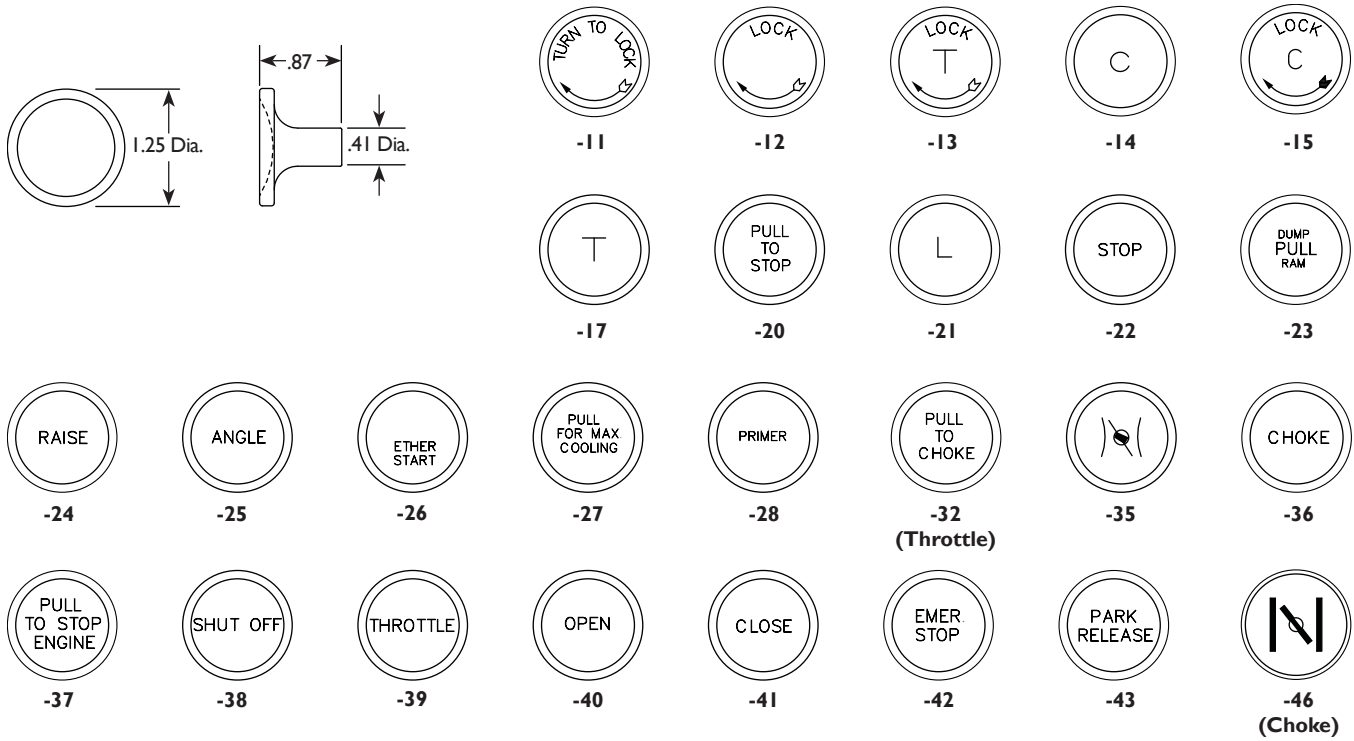

## 30-0405-01 Soft Touch Knob

Contact Your Wescon Application Engineer for Custom Branding

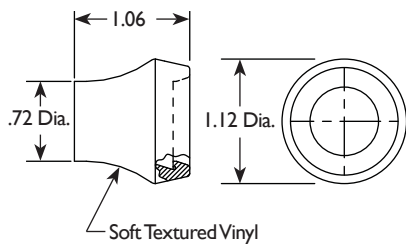

## 30-0109-01 Tee (Flat Top)

May Be Installed on Lever or Rod

Contact Your Wescon Application Engineer for Custom Branding

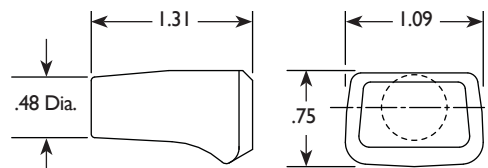

# Knobs & Brands

## 30-0117-00 T-Handle Knob

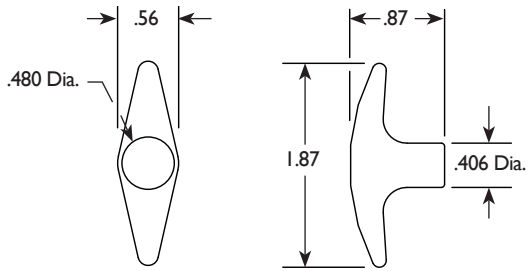

## 25-0559-\* Brands for 30-0117 Knob

\*Insert Dash No.

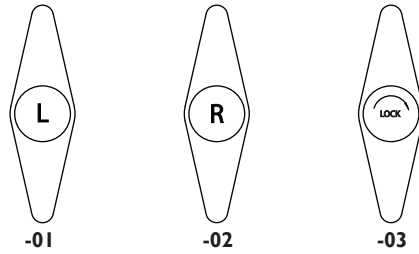

## 30-0129 T-Handle Knob

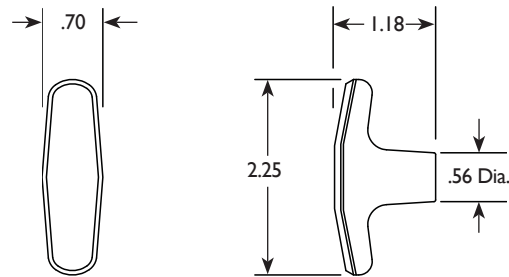

## 25-0535-\* Brands for 30-0129 Knob

\*Insert Dash No.

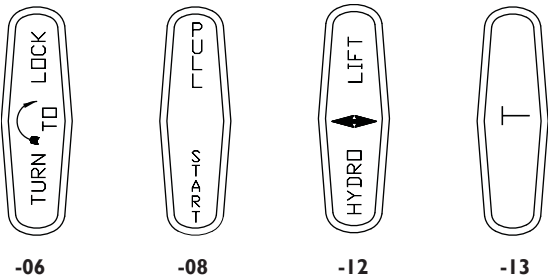

## 30-0142-\* T-Handle Knob

\*Insert Dash No.

Specify Color (Black is Standard)

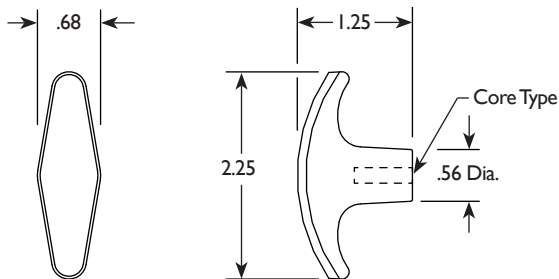

## 25-0582-\* Brands for 30-0142 Knob

\*Insert Dash No.

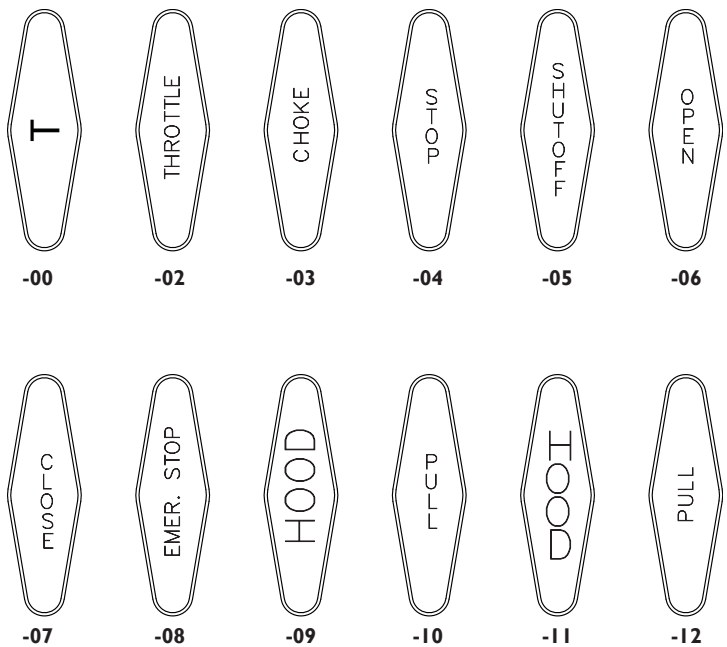

# Conduit Clips

## 22-2152-\* Conduit Clip

\*Insert Dash No.

Part No.	Conduit Size	Mounting Hole	"A"	"B"	Finish
-01	3/16 Cov. or 7/32 Bare	.200 Dia Hole	.44	.25	Bright
-05	3/16 Cov. or 7/32 Bare	.263 Dia Hole	.56	.25	Bright
-07	3/16 Cov. or 7/32 Bare	.227 Dia Hole	.50	.25	Bright
-24	3/16 Cov. or 7/32 Bare	No Hole	.56	.25	Bright
-31	3/16 Cov. or 7/32 Bare	.27 x .39 Slot	.37	.32	Yellow
-38	3/16 Cov. or 7/32 Bare	.263 Dia Hole	.56	.25	Black
-39	3/16 Cov. or 7/32 Bare	.27 x .39 Slot	.37	.32	Black
-42	.230 Bare	.263 Dia Hole	.56	.25	Bright

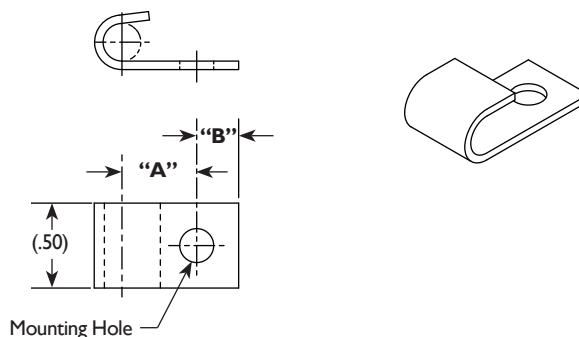

## 22-2152-\* Conduit Clip - Anti-Rotational

\*Insert Dash No.

Part No.	Conduit Size	Mounting Hole	"A"	"B"	"C"	"D"	Finish
-15	3/16 Cov. or 7/32 Bare	.21 x .34 Slot	.41	.34	.25	.15	Bright
-18	3/16 Cov. or 7/32 Bare	.21 x .34 Slot	.41	.34	.25	.15	Yellow
-40	7/32 Cov. or 1/4 Bare	.19 x .26 Slot	.43	.357	.19	.205	Yellow
-41	.312 Covered	.26 Dia Hole	.53	.33	.25	.18	Yellow

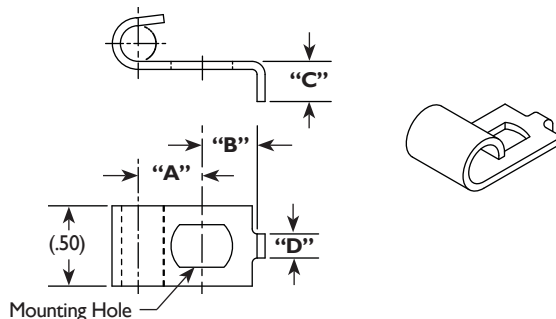

## 22-2152-\* Loose String-On Clip

\*Insert Dash No.

Usage: 3/16 Dia Covered, 7/32 Bare Conduit & 6 Wire  
Finish: Black

Part No.	Mounting Hole	"A"
-03	.218 Dia Hole	.62
-43	.27 x .27 Slot	.78

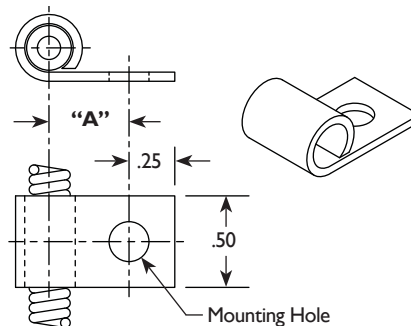

## 22-2115-\* Conduit Clip

\*Insert Dash No.

Part No.	Conduit Size	"A"	Finish
-00	3/16 Bare	.22	Yellow
-02	7/32 Bare	.28	Clear
-03	1/4 Bare	.28	Clear
-04	3/16 Bare	.28	Clear
-05	7/32 Bare	.22	Clear
-11	7/32 Bare or 3/16 Covered	.28	Clear
-12	3/16 Bare	.28	Clear

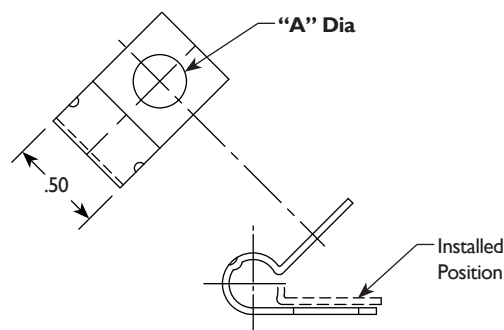

## 22-0183-00 Dual Conduit Clamp

Material: Steel

Finish: Zinc Plate

Usage: 3/16 or 7/32 Dia Conduit

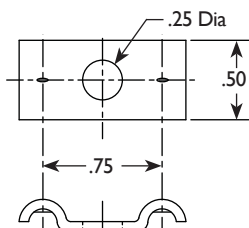

## 22-2054-00 Single Conduit Clamp

Material: Steel

Finish: Zinc Cobalt

Usage: 3/16 or 7/32 Dia Conduit

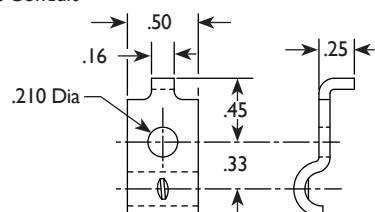

# Seals & Wipers

## 23-3210-\* Cable Seal

\* Insert Dash No.

Dash No.	Cable Size	"A"	Color
-01	3/64 & 1/16	.056	Black
-02	3/32	.084	Black
-03	5/64	.076	Black
-04	3/32 & 1/16	.056	Grey

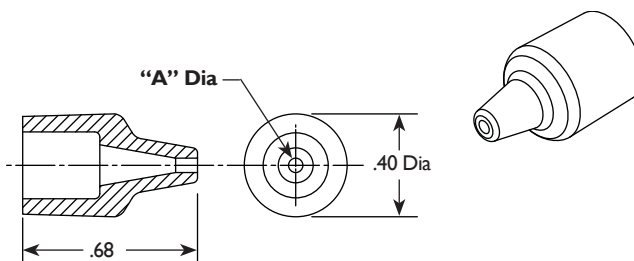

## 23-3107-01 Grommet

For .062 Dia Solid Wire, 7/32 Dia Covered or 1/4 Dia Bare Conduit

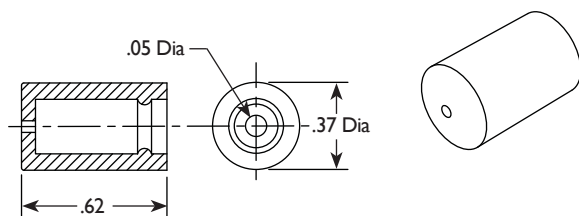

## 23-3109-01 Grommet

For .062 Dia Cable w/21-1060-18 Fitting

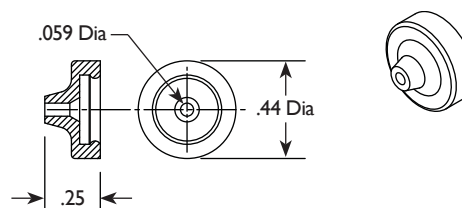

## 80-3112\* Boot

\* Insert Dash No.

Dash No.	"A"	"B"	"C"	Color
-00	.375	5/8	5/32	Black
-01	.281	1/2	3/32	Red
-02	.343	1/2	3/32	Black
-03	.281	1/2	1/16	Black
-04	.343	1/2	.200	Black
-05	.375	3/8	.155	Red

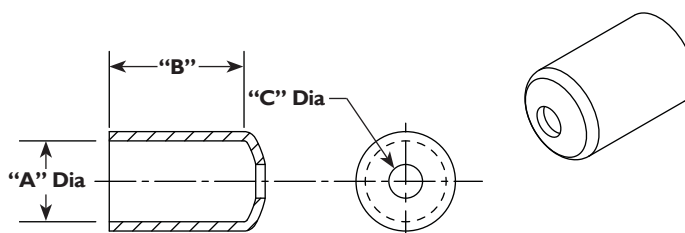

## 23-3243-\* Seal

\* Insert Dash No.

Dash No.	"A"	Color
-01	.076	Grey
-02	.056	Black
-03	.092	Black

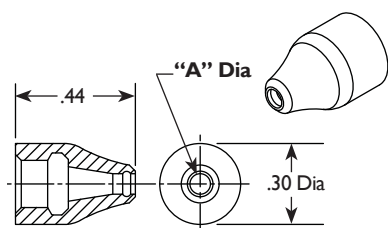

## 23-3041-00

For 3/16 Bare Conduit  
Used in Temperatures Up to 300° F Applications

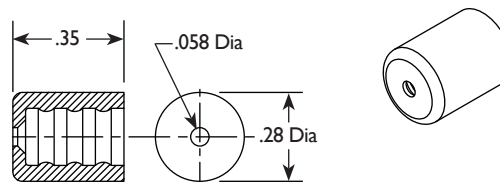

## 23-3040-\* Grommet

\* Insert Dash No.

Dash No.	Conduit	Color
-00-01	3/16 Cov. or 7/32 Bare	Black
-01-04	.187 Bare	Grey

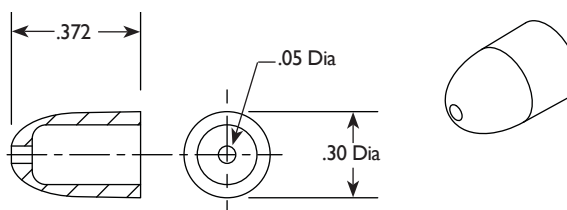

# Innerwire End Bends

## “Z” Bend

Standard Bend Configuration - Will be furnished unless otherwise specified.

Bend No.	“X”	“Y”	Bend No.	“X”	“Y”	Bend No.	“X”	“Y”
00-0122	.125	.125	00-0135	.156	.500	00-0146	.219	.313
00-0125	.125	.313	00-0136	.188	.125	00-0147	.219	.375
00-0126	.125	.375	00-0138	.188	.250	00-0148	.219	.437
00-0127	.125	.437	00-0139	.188	.313	00-0149	.219	.500
00-0128	.125	.500	00-0140	.188	.375	00-0152	.250	.250
00-0129	.156	.125	00-0141	.188	.437	00-0163	.125	.062
00-0131	.156	.250	00-0142	.188	.500	00-0164	.125	.219
00-0132	.156	.313	00-0143	.219	.125	00-0166	.188	.219
00-0133	.156	.375	00-0144	.219	.188	00-0167	.135	.214
00-0134	.156	.437	00-0145	.219	.313	00-0168	.250	.125

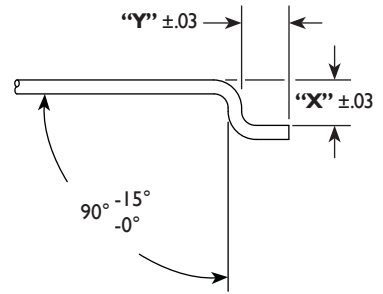

## “L” Bend

Bend No.	“X”	Bend No.	“X”
00-0303	.250	00-0309	.625
00-0304	.312	00-0311	.750
00-0305	.375	00-0313	.875
00-0306	.437	00-0315	1.00
00-0307	.500	00-0319	1.25
00-0308	.562	00-0321	1.50

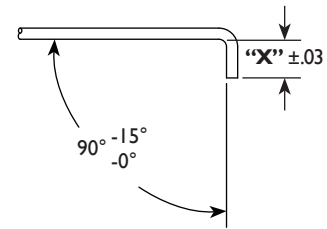

## Centered Loop

Bend No.	I.D.	Number of Coils	Bend No.	I.D.	Number of Coils
00-3101	.250	1 1/2	00-3111	.192	1 3/4
00-3102	.250	3	00-3115	.265	2
00-3103	.192	3	00-3119	.109	4
00-3104	.261	3	00-3120	.314	1 1/2
00-3106	.192	2	00-3121	.192	1 1/2

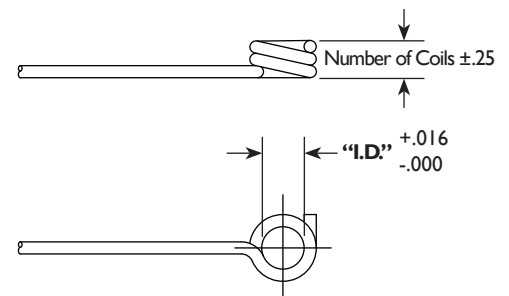



# TAKE A LOOK AT OTHER WESCON PRODUCTS

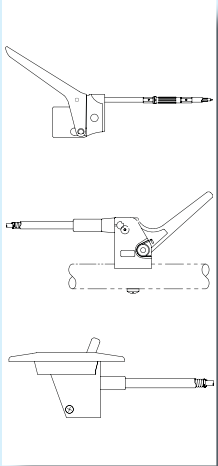

Controls for a world in motion



Light Duty Lever Controls

Controls for a world in motion

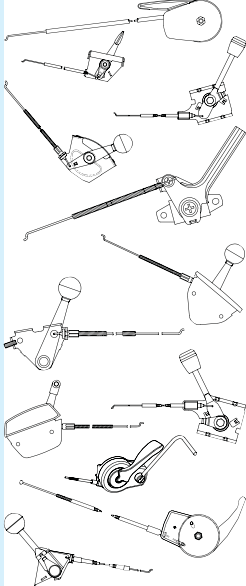

Outdoor Power Equipment Controls



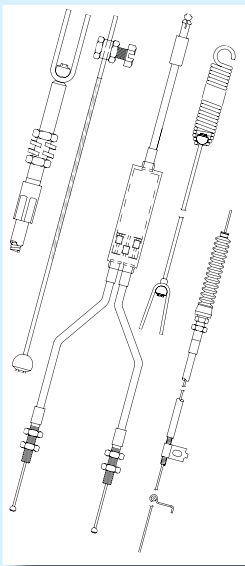

Controls for a world in motion



Accessories

Controls for a world in motion

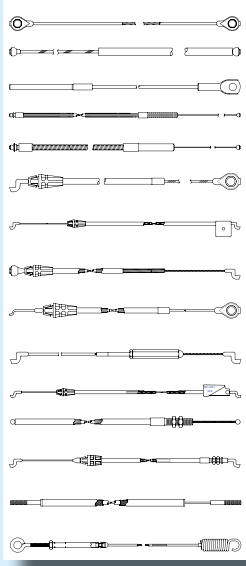

Light Duty Tension Cable Controls



Controls for a world in motion

## WESCON CONTROLS

P.O. Box 7710 Wichita, Kansas 67277

316-942-7266 or call toll free 1-800-835-0160

Fax 316-942-5114

[www.wesconproducts.com](http://www.wesconproducts.com)

ISO 9001 CERTIFIED